

MPI LCS-635 | Laser Cutter System

For accurate and reliable Failure Analysis and Design Validation Applications

FEATURES / BENEFITS

High Cutting Productivity

- Precise, compact Diode Pump Solid State Laser
- High beam quality, even at 266 nm
- Standard high energy range (up to 1.2 mJ)
- Enhanced pulse-to-pulse stability

Configuration Flexibility

- Variable configurations based on 1064 nm, 532 nm, 355 nm or 266 nm wavelengths
- 2.5 mm standard shutter, 4 mm as an option
- Rotating shutter as a standard feature
- Embedded c-mount adapter

High Efficiency and Reliability

- Passive conductive laser head cooling
- Low energy consumption (max. 100 W)
- Long live time > 500,000,000 pulses
- Low maintenance (no water leaks)

Intuitive Operation

- SMART Controller with intuitive, touch-screen GUI
- Easy access to all parameters settings
- Fast daily work by using four function buttons
- Saving of up to 6 user defined cutting recipes



SPECIFICATIONS

Laser Type	Diode Pump Solid State Laser, sealed, conductively cooled resonator, integrated with drive and control electronics.					
Variable Wavelength	1064 nm					
Single or two wavelengths configurations	532 nm					
	532 nm & 1064nm					
	532 nm & 355 nm					
	532 nm & 266 nm					
Repetition Rate	Single shot mode					
	Continuous mode @ 20 Hz					
	Burst mode @ 40 Hz up to 10 seconds					
Pulse Specifications						
Wavelength	Energy *	Pulse Width **	Pulse Stability @ Full, 50%, 25%, 10% Aperture ***			
1064 nm	≥ 1.2 mJ	≤ 12 ns	≤3.0%	≤3.5%	≤4.0%	≤6.0%
532 nm	≥ 1.2 mJ	≤ 12 ns	≤3.5%	≤4.0%	≤4.5%	≤6.5%
355 nm	≥ 0.4 mJ	≤ 12 ns	≤4.0%	≤5.0%	≤6.0%	≤8.0%
266 nm	≥ 0.4 mJ	≤ 12 ns	≤4.0%	≤5.0%	≤6.0%	≤8.0%

* Energy is specified at the output of the system and does not include losses from the optics. High energy level optional available on request

** At max aperture, 50% energy

*** RMS pulse-to-pulse stability for 98% of pulses after warm-up, with a 100 shot sample window

Laser Diode Lifetime	> 500,000,000 pulses
-----------------------------	----------------------

Attenuator Specifications

Attenuation Range	0 to 100%
Accuracy	±0.5%
Resolution	0.20%
Tact Time @ full range	≤ 1.0 s
Initialization (from power up)	≤ 6.0 s

X-Y Mechanical Aperture

X-Y Range	X: 0 to 2.5 mm, Y: 0 to 2.5 mm, X: 0 to 4 mm, Y: 0 to 4 mm (optional)
Accuracy	± 25 μm + 0.01% of the cut size
Resolution	25 μm

Aperture Rotation

Rotation Range	-45 to +45 degrees
Accuracy	± 1.0 degree
Resolution	0.5 degrees

SMART Controller

GUI	Intuitive, touch-screen GUI
Customs Function Positions	4
User Defined Cutting Recipes	6
Video In/Out	BNC, S-Video
Computer Interface	USB
Aperture Frame Projection	By using MPI analog camera option

PC Interface

Interface (used by SMART Controller)	RS232
--------------------------------------	-------

TYPICAL APPLICATIONS

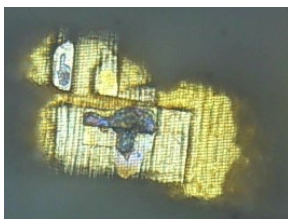

Remove EPOXY on surface by 266 nm

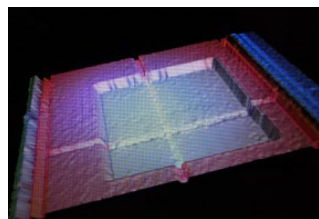

Remove RGB color filter and keep metal line by 266 nm

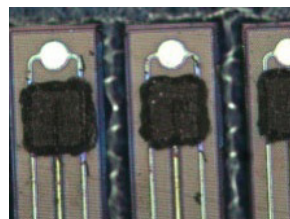

Laser marking for NGD (likes INK function) by 532 nm

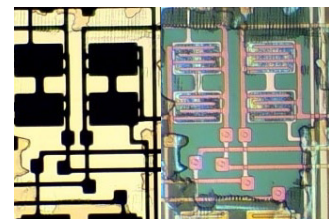

Remove polyimide passivation surface by 266 nm

SMART CONTROLLER



MICROSCOPE* APPLICATION MATRIX

Microscope	1064 nm	532 nm	355 nm	266 nm
FS70L	Yes	Yes	Yes	Not recommended
FS70L4	Not recommended	Yes	Yes	Yes
PSM1000	Yes	Yes	Yes	Not recommended
VIS-200	Yes	Not recommended	Not recommended	Not recommended
VMU-LB	Yes	Yes	Yes	Not recommended
VMU-L4B	Yes	Yes	Yes	Yes

* Other laser cutter compatible microscopes, on requests

For laser cutting is strongly recommended to use objectives 50x and higher. Below, the resulting energy density may be too low to effect the DUT.



DIMENSIONS

Dimensions

Laser Head (W x D x H)	195 x 80 x 300 mm (7.7 x 3.1 x 11.8 in)
Power Supply (W x D x H)	130 x 250 x 255 mm (5.1 x 9.8 x 10.0 in)
SMART Controller (W x D x H)	227 x 70 x 168 mm (8.9 x 2.8 x 6.6 in)

Weight

Laser Head	5.5 kg
Power Supply	≤ 4.5 kg
SMART controller	0.5 kg

Specification

Operating Voltage	100 - 240 VAC, 50/60 Hz
Operating Power	< 100 W
Remote Control	RS-232

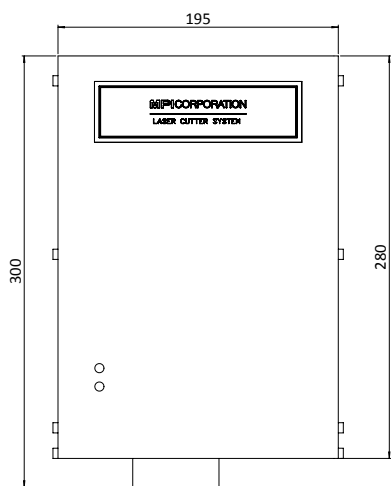

Dimensions of the Laser Head

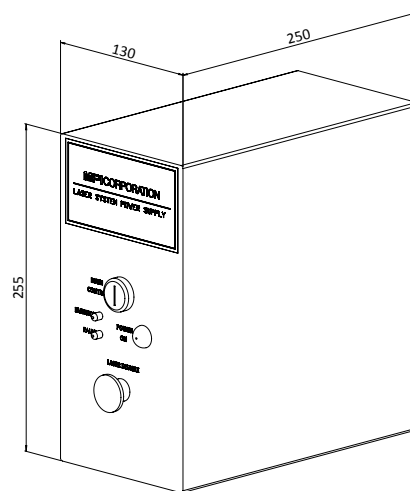
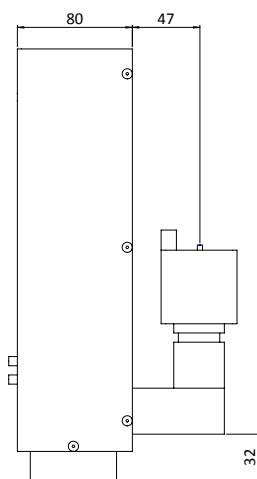

Dimensions of the Power Supply

*See MPI Corporation's Terms and Conditions of Sales for more details.

Direct contact:
 Asia region: ast-asia@mpi-corporation.com
 EMEA region: ast-europe@mpi-corporation.com
 America region: ast-americas@mpi-corporation.com

MPI global presence: for your local support, please find the right contact here:
www.mpi-corporation.com/ast/support/local-support-worldwide

© 2023 Copyright MPI Corporation. All rights reserved.

MPI Global Presence

