

# MPI TS2500 Series | 200 mm Fully Automated Probe System

## For accurate and reliable RF and High Power 24/7 Production Tests

### FEATURES / BENEFITS

#### Designed for Wide Variety of On-Wafer Applications

- RF measurements up to 67 GHz & 4-port setup
- Integration of broadband measurements up to 220 GHz
- Simultaneously for RF, DC-IV / DC-CV / Pulsed-IV measurements
- High Power applications up to 10 kV/400 A

#### Production Reliability

- Designed for 24/7 production reliability
- Safety cover with interlocks providing a closed environment

#### Ergonomic Design and Options

- Designed with easy single wafer front loading and unloading
- Large Probe Platen supporting up to 4x RF MicroPositioners or standard 4.5" / 6.5" probe card holder
- Standard two cassettes for 100, or 150 or 200 mm wafers
- Available with various ambient or thermal chucks from 20 to 300 °C
- Wide range of on-axis optics in addition to
- Standard off-axis wafer alignment camera
- Optional upper looking chuck camera for probe-to-pad alignment
- Dedicated thin wafer handling option down to 50 µm

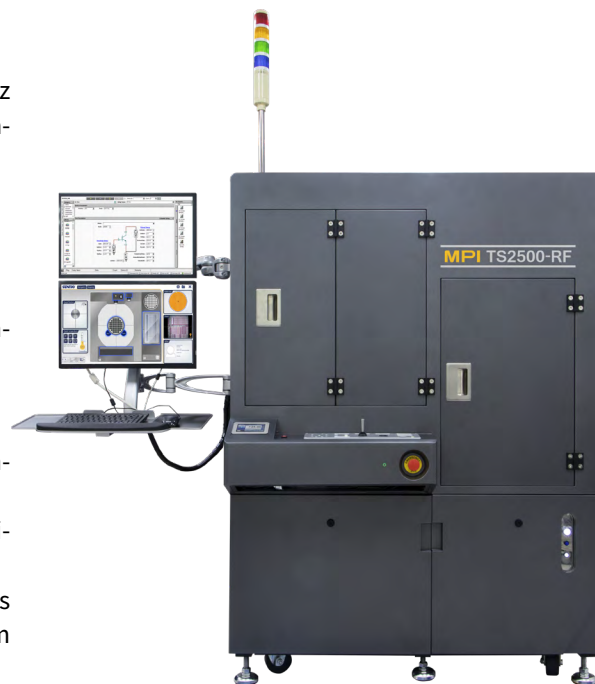

### SPECIFICATIONS

#### Chuck XY Stage (Programmable)

Travel range	298 mm x 350 mm (11.7 x 13.7 in)
Resolution	0.1 µm
Accuracy	< 4.0 µm
Repeatability	< 2.0 µm

#### Chuck Z Stage (Programmable)

Travel range	16 mm (0.6 in)
Resolution	0.2 µm
Repeatability	< 1.0 µm

#### Chuck Theta Stage (Programmable)

Travel range	± 5.0°
Resolution	0.00125°
Accuracy	< 3.0 µm (measured at the edge of the 200 mm chuck)

**ALIGNMENT TOOLS**

**Off Axis Camera Specifications**

Number of pixels	2 MP
Optical resolution	1296 x 966
Field of view	4.8 x 3.6 mm
Illumination	Ring and coaxial light

**Optional Upward Looking Camera Specifications**

Number of pixels	2 MP
Optical resolution	1296 x 966
Field of view	2.4 x 1.8 mm
Illumination	Ring light

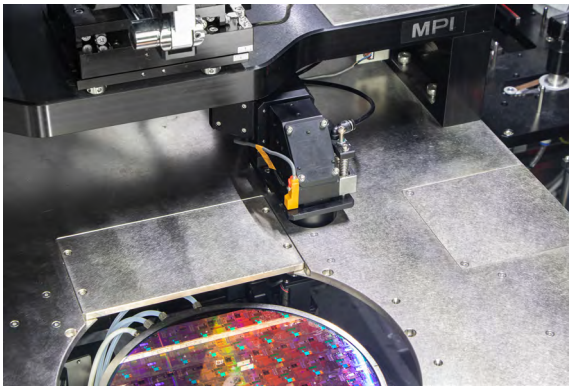

Off-axis wafer alignment camera

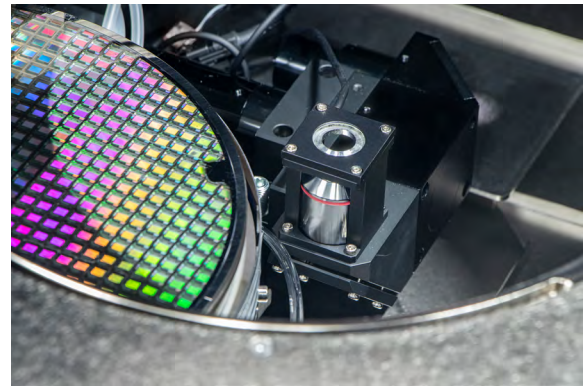

Optional upper looking chuck camera for probe-to-pad alignment

**SOFTWARE SOLUTION**

Unique and revolutionary multi-touch operation software SENTIO® controls MPI automated engineering probe systems. Its simple and intuitive operation concept significantly saves operator training time. Scroll, Zoon, and Move functions mimic modern smart mobile device interface. Switching between applications is just a matter of a simple finger swipe.

SENTIO® makes everyone the system operation expert in just minutes.

SENTIO® supports two SEMI standard cassettes from 3” to 200 mm for automated or manual wafer loading. Advanced and fast Wafer ID-Reader for top or bottom ID reading is optional available, providing revolutionary integrated RGB illumination and fully automatic exposure control.

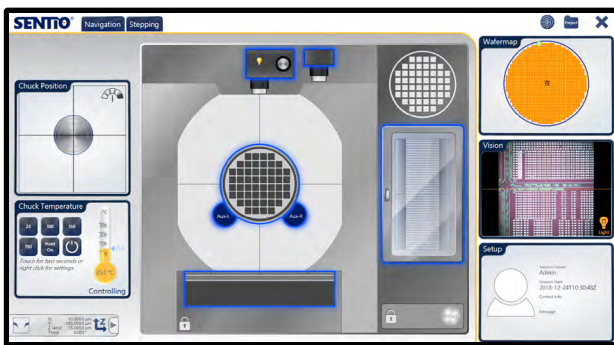

■ PROBE PLATEN

**Specifications**

Material	Nickel plated steel
Chuck to platen height	28 mm
Feature	Configurable with probe card and MicroPositioners
Max. No. of MicroPositioners	4 RF MicroPositioner setup

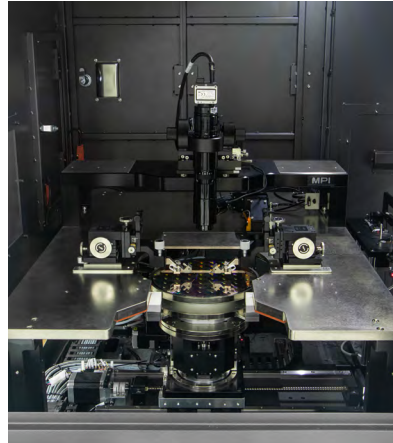

Typical setup with TITAN™ 26 GHz RF Probes

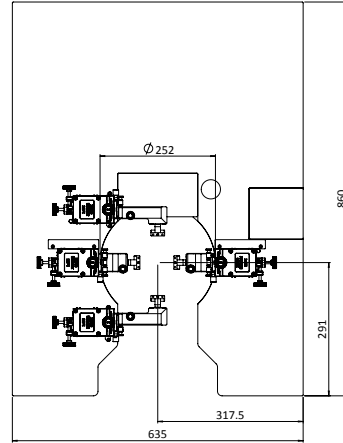

Probe platen design

■ WAFER LOADING

**Specifications**

Wafer size	100, 150, 200 mm (4, 6, 8 in) or 75, 100, 150 mm (3, 4, 6 in)
Cassette type	Semi E1
Cassette capacity	2
Cassette loading time*	15 sec cassette (wafer scan)
First Wafer loading time*	40 sec (cassette → pre-alignment → chuck)
Next wafer exchange time*	40 sec (chuck → wafer unload and next wafer → chuck)
Thin wafer exchange function	Smart recipe for thin wafer lifting
Wafer support	Conventional and thin Wafer down to 50 μm
Pre-aligner	Optical, support notch and flats
Wafer ID reader (optional)	Optical, can configure top or bottom
Wafer scanning	Laser scanning for wafer indexing

\*Typical values, depending on wafer size, thickness and surface condition

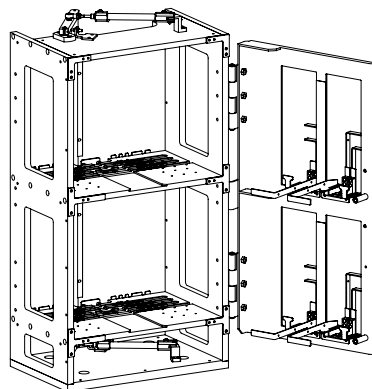

TS2500-RF cassette station supports up to two 200 mm or two 150 mm or two 100 mm cassettes

**HIGH POWER PROBE ACCESSORIES**

**High Voltage Probe (HVP)**

Low leakage probes specially designed to withstand high voltage up to 10 kV (coaxial) and 3 kV (triaxial). Choice of various connectors options such as Keysight Triax/UHV, Keithley Triax/UHV, SHV or Banana.

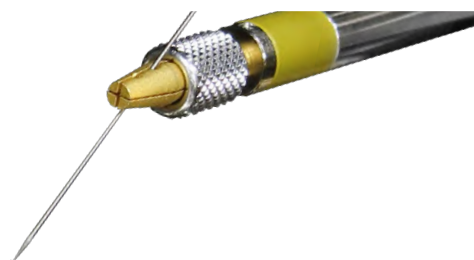

**High Current Probe (HCP)**

High performance probes specially designed for on wafer measurement of high current up to 200 A (pulse). MPI multi-fingers high current probes are single piece construction to efficiently handle high current and provide low contact resistance.



**Ultra High Power Probe (UHP)**

Designed for Ultra high voltage and current on wafer measurement up to 10 kV/600 A (pulse). MPI replaceable multi-fingers probes tips and probe arms are design for low contact resistance for ultra-high current measurement and to support ultra-high voltage of up to 10 KV, without having to change probes for high voltage and current application.



**HIGH POWER PROBES - SELECTION GUIDE**

	High current probes			High voltage probes		
	3 fingers	5 fingers	7 fingers	PA-HVT	PA-HVC	PA-HVC-10KV
Max current	40 A	65 A	100 A	2 A	2 A	2 A
Max voltage	500 V	500 V	500 V	3,000 V	5,000 V	10,000 V
Residual resistance (Typical)	≤ 5 mΩ	≤ 3 mΩ	≤ 1 mΩ	--	--	--
Leakage @ max. V	--	--	--	≤ 1 pA	≤ 600 pA	> 35 TΩ
Connector options	Banana <sup>[3]</sup> plug or BNC <sup>[4]</sup>			HV triaxial <sup>[2]</sup>	SHV	10 KV UHV or banana <sup>[3]</sup> plug
Replaceable tip	Yes	Yes	Yes	Yes	Yes	Yes
Probe pitch <sup>[1]</sup>	350 μm (Std)	350 μm (Std)	350 μm (Std)	Single needle	Single needle	Single needle

<sup>[1]</sup>Configurable

<sup>[2]</sup>Keysight or Keithley

<sup>[3]</sup>Banana: 100 A max, 1 ms max PW, 1% max PLC

<sup>[4]</sup>BNC: 40 A max, 1 ms max PW, 1% Max PLC

## ULTRA HIGH POWER PROBES - SELECTION GUIDE

	1 finger	4 fingers	6 fingers	8 fingers	12 fingers
Max current*	20 A	80 A	120 A	160 A	250 A
Max voltage	10 KV	10 KV	10 KV	10 KV	10 KV
Residual resistance (Typical)	≤ 5 mΩ	≤ 3 mΩ	≤ 1 mΩ	≤ 1 mΩ	≤ 1 mΩ
Connector options	Banana	Banana	Banana	Banana	Banana
Replaceable tip	Yes	Yes	Yes	Yes	Yes
Probe tip width	250 μm	250 μm	250 μm	250 μm	250 μm
Probe pitch	--	650 μm	650 μm	650 μm	650 μm

\*1 ms Max PW, 0.4% max PLC

## HIGH POWER PROBE CARDS

Max current	250 A
Max voltage	10 KV
Max pressure	8 bar
Max chamber diameter	25 mm
Max probe pin needles	20
Probe pin needle diameter	100 μm
Connector type	Keysight HV, Keithley HV, SHV, BNC, Banana, M HV
Air pressure requirement	CDA up to 8 bar

## NON-THERMAL CHUCKS

### RF Wafer Chuck

	150 mm	200 mm
Connectivity	Coax BNC (f)	Coax BNC (f)
Diameter	150 mm with 2 integrated AUX areas	210 mm with 2 integrated AUX areas
Material	Nickel plated aluminum (flat with 0.5 mm holes)	Nickel plated aluminum (flat with 0.5 mm holes)
Chuck surface	Planar with 0.5 mm diameter holes in centric sections	Planar with 0.5 mm diameter holes in centric sections
Vacuum holes sections (diameter)	3, 27, 45, 69, 93, 117, 141 mm	3, 27, 45, 69, 93, 117, 141, 164, 194 mm
SmartVacuum™ distribution	In center for 5x5 mm (4 holes), 50, 100, 150 mm (2, 4, 6 in)	In center for 5x5 mm (4 holes), 100, 150, 200 mm (4, 6, 8 in)
Supported DUT sizes	Single DUTs down to 5 x 5 mm size or wafers 50 mm (2 in) thru 150 mm (6 in)*	Single DUTs down to 5 x 5 mm size or wafers 100 mm (4 in) thru 200 mm (8 in)*
Surface planarity	≤± 5 μm	≤± 5 μm
Rigidity	< 15 μm / 10 N @edge	< 15 μm / 10 N @edge
Lift pin	9	13

\*Single DUT testing requires higher vacuum conditions dependent upon testing application.

### Auxiliary Chuck

Quantity	2 AUX chucks
Position	Integrated to front side of main chuck
Substrate size (W x L)	Max. 25 x 25 mm (1 x 1 in)
Material	Ceramic, RF absorbing material for accurate calibration
Surface planarity	≤± 5 μm
Vacuum control	Controlled independently, separate from chucks

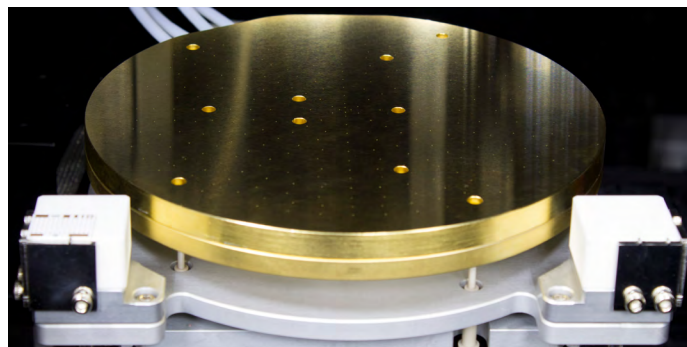

Gold plated RF chuck with lift pins for thin wafer handling



## THERMAL CHUCKS

### Specifications of MPI ERS AirCool® Technology

	Ambient to 150/200 °C	20 °C to 150/200 °C
Connectivity	Coax BNC (f)	Coax BNC (f)
Temperature control method	Cooling air / Resistance heater	Cooling air / Resistance heater
Coolant	Air (user supplied)	Air (user supplied)
Smallest temperature selection step	0.1 °C	0.1 °C
Chuck temperature display resolution	0.1 °C	0.1 °C
External touchscreen display operation	N/A	N/A
Temperature stability	±0.5 °C	±0.5 °C
Temperature accuracy	±1 °C	±1 °C
Control method	DC/PID	DC/PID
Chuck pinhole surface plating: 200 °C	Nickel	Nickel
SmartVacuum™ distribution	In center for 5x5 mm (4 holes), 100, 150, 200 mm (4, 6, 8 in)	
Temperature sensor	Pt100 1/3DIN	Pt100 1/3DIN
Temperature uniformity	< ±1 °C	< ±1 °C
Surface flatness and base parallelism	< ±15 µm	< ±15 µm
Max. Voltage between		
Force-to-GND	500 V DC	500 V DC
Heating rates*	35 to 150 °C < 12 min 35 to 200 °C < 18 min	20 to 150 °C < 12 min 20 to 200 °C < 23 min
Cooling rates*	150 to 35 °C < 15 min 200 to 35 °C < 18 min	150 to 20 °C < 18 min 200 to 20 °C < 30 min
Leakage @ 10 V	N/A	N/A
Electrical isolation	> 0.5 T Ω at 25 °C	> 0.5 T Ω at 25 °C
Capacitance	< 750 pF	< 750 pF

\*Typical data for all chucks based on FPS requirements.

**Specifications of MPI ERS AirCool® PRIME Technology**

	Ambient to 200/300 °C	20 °C to 200/300 °C	Ambient to 200/300 °C	20 °C to 200/300 °C
Chuck type	RF	RF	Ultra low noise	Ultra low noise
Connectivity	Kelvin Triax (f)	Kelvin Triax (f)	Kelvin Triax (f)	Kelvin Triax (f)
Temperature control method	Cooling air / Resistance heater	Cooling air / Resistance heater	Cooling air / Resistance heater	Cooling air / Resistance heater
Coolant	Air (user supplied)	Air (user supplied)	Air (user supplied)	Air (user supplied)
Smallest temperature selection step	0.1 °C	0.1 °C	0.1 °C	0.1 °C
Chuck temperature display resolution	0.01 °C	0.01 °C	0.01 °C	0.01 °C
External touchscreen display operation	Yes	Yes	Yes	Yes
Temperature stability	±0.08 °C	±0.08 °C	±0.08 °C	±0.08 °C
Temperature accuracy	±0.1 °C	0.1 °C	0.1 °C	0.1 °C
Control method	Low noise DC/PID	Low noise DC/PID	Low noise DC/PID	Low noise DC/PID
Chuck pinhole surface plating: 200°C / 300°C	Nickel / Gold	Nickel / Gold	Nickel / Gold	Nickel / Gold
SmartVacuum™ distribution		In front for single DUT 5x5 mm (4 holes) In center for 100, 150, 200 mm (4, 6, 8 in)		
Temperature sensor	Pt100 1/3DIN, 4-line wired	Pt100 1/3DIN, 4-line wired	Pt100 1/3DIN, 4-line wired	Pt100 1/3DIN, 4-line wired
Temperature uniformity	< ±0.5 °C at ≤ 200 °C < ±1 °C at > 200 °C	< ±0.5 °C at ≤ 200 °C < ±1 °C at > 200 °C	< ±0.5 °C at ≤ 200 °C < ±1 °C at > 200 °C	< ±0.5 °C at ≤ 200 °C < ±1 °C at > 200 °C
Surface flatness and base parallelism	< ±12 μm	< ±12 μm	< ±12 μm	< ±12 μm
Max. Voltage between				
Force-to-GND	600 V DC	600 V DC	600 V DC	600 V DC
Force-to-Guard	100 V DC	100 V DC	600 V DC	600 V DC
Guard-to-GND	400 V DC	400 V DC	400 V DC	400 V DC
Heating rates*	35 to 200 °C < 16 min 35 to 300 °C < 20 min	20 to 200 °C < 15 min 20 to 300 °C < 22 min	35 to 200 °C < 18 min 35 to 300 °C < 26 min	20 to 200 °C < 16 min 20 to 300 °C < 28 min
Cooling rates*	200 to 35 °C < 27 min 300 to 35 °C < 33 min	200 to 20 °C < 33 min 300 to 20 °C < 40 min	200 to 35 °C < 27 min 300 to 35 °C < 34 min	200 to 20 °C < 41 min 300 to 20 °C < 42 min
Leakage @ 10 V	N/A	N/A	< 15 fA at 25 °C < 30 fA at 200 °C < 50 fA at 300 °C	< 15 fA at 25 °C < 30 fA at 200 °C < 50 fA at 300 °C
Electrical isolation	> 5 T Ω at 25 °C > 1 T Ω at 200 °C > 0.5 T Ω at 300 °C	> 5 T Ω at 25 °C > 1 T Ω at 200 °C > 0.5 T Ω at 300 °C	N/A	N/A
Capacitance				
Force-to-Guard	< 1600 pF	< 1600 pF	< 600 pF	< 600 pF
Guard-to-Shield	< 2000 pF	< 2000 pF	< 2000 pF	< 2000 pF

\*Typical data for all chucks based on FPS requirements.



**NON-THERMAL HIGH POWER CHUCKS**

**High Power Wafer Chucks**

Connectivity 1	10 kV Coaxial (Banana or SHV)
Connectivity 2	Kelvin Triax (f), 3 kV or 10 kV Coaxial
Diameter	210 mm with 2 integrated AUX areas
Material	Gold plated aluminum (flat with 100 µm holes)
Chuck surface	Planar with 0.5 mm diameter holes in centric sections
Vacuum holes sections (diameter)	3, 27, 45, 69, 93, 117, 141, 164, 194 mm
SmartVacuum™ distribution	In center for 5x5 mm (4 holes), 100, 150, 200 mm (4, 6, 8 in)
Supported DUT sizes	Single DUTs down to 5 x 5 mm size or wafers 100 mm (4 in) thru 200 mm (8 in)*
Surface planarity	≤± 5 µm
Rigidity	< 15 µm / 10 N @edge

\*Single DUT testing requires higher vacuum conditions dependent upon testing application.

**Electrical Specification (Triax)**

Chuck isolation	> 30 TΩ
Force to guard	> 30 TΩ
Guard to shield	> 500 GΩ
Force to shield	> 100 GΩ

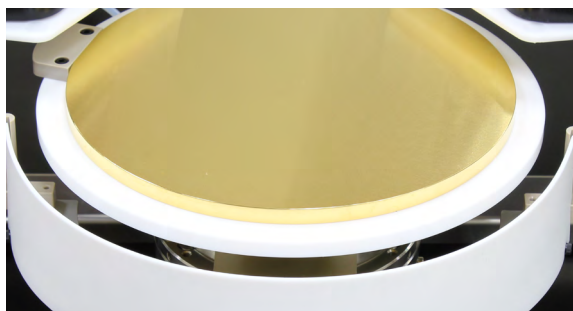

MPI Non-thermal Triaxial High Power Chuck with gold plated surface for low contact resistance



MPI 10 kV Triaxial Connector used for Kelvin chuck connection

**HIGH POWER THERMAL CHUCKS**

**Specifications of MPI ERS Integrated Technology**

Temperature Range	20 to 200 °C	20 to 300 °C
Connectivity	Kelvin Triax (f), 3 kV or 10 kV Coaxial	Kelvin Triax (f), 3 kV or 10 kV Coaxial
Temperature control method	Cooling air / Resistance heater	Cooling air / Resistance heater
Coolant	Air (user supplied)	Air (user supplied)
Smallest temperature selection step	0.1 °C	0.1 °C
Chuck temperature display resolution	0.01 °C	0.01 °C
External touchscreen display operation	Yes	Yes
Temperature stability	±0.08 °C	±0.08 °C

Temperature accuracy	0.1 °C	0.1 °C
Control method	Low noise DC/PID	Low noise DC/PID
Interfaces	RS232C	RS232C
Chuck surface plating	Gold plated with pinhole surface	Gold plated with pinhole surface
Temperature sensor	Pt100 1/3DIN, 4-line wired	Pt100 1/3DIN, 4-line wired
Temperature uniformity	< ± 0.5 °C	< ±0.5 °C at ≤ 200 °C < ±1.0 °C at > 200 °C
Surface flatness and base parallelism	< ±10 µm	< ±10 µm at ≤ 200 °C < ±15 µm at > 200 °C
Heating rates	20 to 200 °C < 31 min	20 to 300 °C < 39 min
Cooling rates*	200 to 20 °C < 65 min	300 to 20 °C < 63 min
Maximum voltage between chuck top and GND	10 kV DC	10 kV DC
Leakage @ 10 V Kelvin Triax (f)		
-60 °C, -40 °C and -10 °C	--	--
25 °C	< 15 fA	< 15 fA
200 °C	< 30 fA	< 30 fA
300 °C	--	< 50 fA
Leakage @ 3000 V Kelvin Triax (f)		
-60 °C, -40 °C and -10 °C	--	--
25 °C	< 5 pA	< 5 pA
200 °C	< 10 pA	< 10 pA
300 °C	--	< 15 pA
Leakage @ 10 kV Coax UHV/SHV (f)		
-60 °C, -40 °C and -10 °C	--	--
25 °C	< 6 nA	< 6 nA
200 °C	< 6 nA	< 6 nA
300 °C	--	< 6 nA

\* All data are relevant for chucks in ECO mode.

**Thermal Controller Dimensions / Power and Air Consumption**

System type	W x D x H (mm)	Weight (kg)	Power cons. (VA)	max. Air flow* (l/min)
20 to 200 °C / 300 °C	300 x 360 x 135	12	700	200

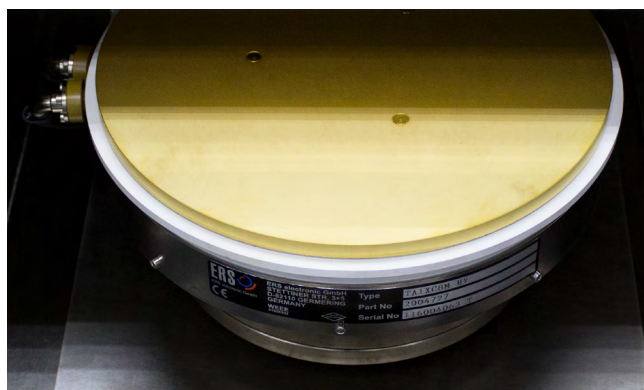

ERS High Power Thermal Chuck

**TYPICAL TRANSITION TIME**

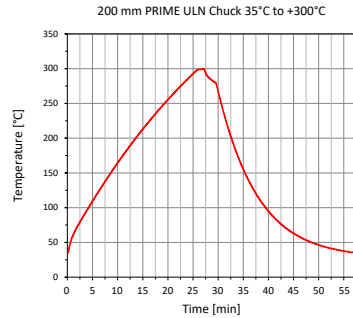
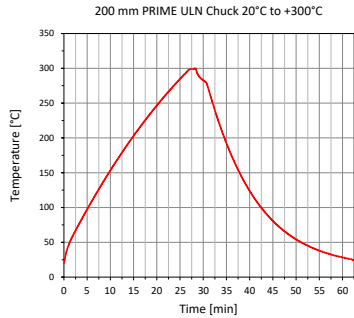
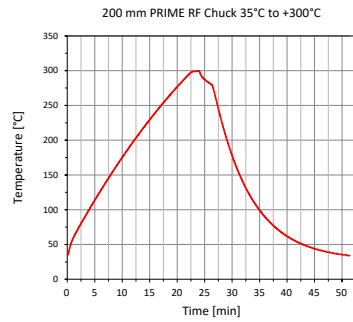
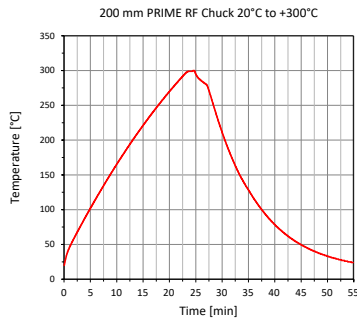

**SYSTEM CONTROLLER SPECIFICATIONS**

CPU	Intel Core i9
RAM	16 GB
64 bit operating system	Windows 11 Enterprise LTSC (English) 64 bit
Storage	500 GB SSD
LAN	1 x internal, 1 x external TCP/IP port
USB Ports	3 x internal, 1 x external
GPIB interface	Optional

**SUPPORTED SOFTWARE PLATFORMS**

Drivers	WaferPro / IC-CAP & EasyEXPERT from Keysight, BSIMPro & NoisePro from ProPlus, ACS from Keithley
Emulation mode	Available for various prober control software*

\* Please contact your local support for more details.

**FACILITY REQUIREMENTS**

**General Probe System**

Power	100-240 V AC nominal ; 50/60 Hz
Vacuum	-0.9 bar
Compressed air	6.0 bar

**REGULATORY COMPLIANCE**

CE, 3rd party tested according to TÜV for IEC 61010-1: 2010 + Am1:2016; UL 61010-1: 2012/R: 2016-04; UL 61010-2-010: 2015; CAN/CSA-C22.2 No. 61010-1: 2012/U2:2016-04; CAN/CSA-C22.2 No. 61010-2-010:2015 and certified for US/Canada (NRTL), SEMI S2 and S8.  
Copies of certificates are available on request

**WARRANTY**

- Warranty\*: 12 months
- Extended service contract: contact MPI Corporation for more information

\*See MPI Corporation's Terms and Conditions of Sale for more details.

**PHYSICAL DIMENSIONS**

**Specifications**

System dimensions (W x D x H)	1350 x 1250 x 1840 mm (53.1 x 49.2 x 72.4 in)
Weight	725 kg

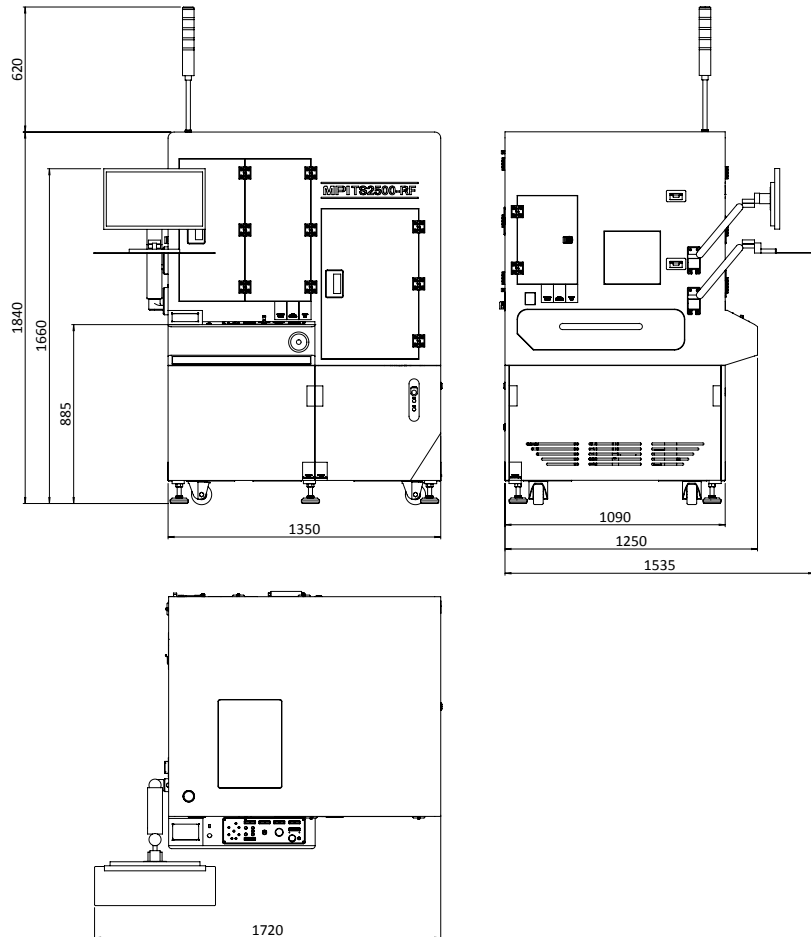

Direct contact:  
 Asia region: [ast-asia@mpi-corporation.com](mailto:ast-asia@mpi-corporation.com)  
 EMEA region: [ast-europe@mpi-corporation.com](mailto:ast-europe@mpi-corporation.com)  
 America region: [ast-americas@mpi-corporation.com](mailto:ast-americas@mpi-corporation.com)

MPI global presence: for your local support, please find the right contact here:  
[mpi-corporation.com/ast/support/regional-sales-contact](http://mpi-corporation.com/ast/support/regional-sales-contact)

© 2025 Copyright MPI Corporation. All rights reserved.

MPI Global Presence

